

THE ENCLAVE at GAINNEY RANCH
STANDARDS and RULES

Table of Contents

- 1. ENCLAVE RESIDENTS DIRECTORY**
- 2. ENCLAVE ARCHITECTURAL GUIDELINES**
 - PAINTING
 - STONE VENEERS
 - STUCCO FINISHES
 - WINDOWS AND DOOR REPLACEMENT
 - ROOF TILES
 - SKYLIGHTS
 - HOUSE NUMBERS
 - EXTERIOR LIGHTING FIXTURES
 - FRONT ENTRY GATES
 - GARAGE DOORS & DRIVEWAYS
 - BUILDING POP-OUTS AND LET-IN DETAILING
 - EXTERIOR BALCONY RAILINGS
 - AWNINGS
 - BALCONIES AND DECKS
 - SHUTTERS FOR WINDOWS AND DOORS
 - DECORATIVE CHIMNEY ELEMENTS
 - ARTIFICIAL PLANTS
 - EXTERNAL AND COMMUNAL WALLS
 - CONSTRUCTION REGULATIONS
 - ACCESSORY GUIDELINE
 - ARTIFICIAL TURF GUIDELINE
 - GUTTERS AND DOWNSPOUTS STANDARDS
- 3. APPROVED VEGETATION**
- 4. APPROVED DUNN-EDWARDS PAINT PALETTE**
- 5. APPROVED SUNBRELLA AWNINGS**

Enclave Architectural Guidelines Approved by Master Architectural Committee

ENCLAVE APPROVED ARCHITECTURAL GUIDELINES:

Gainey Ranch was envisioned by the original developer as the premiere address in all of Scottsdale Arizona with The Enclave being the finest project within Gainey itself. The Enclave was originally envisioned as a community of 57 homes and has now expanded to sixty-six individual residences. These homes and this satellite were given the role of setting the standard of excellence for a community within Gainey Ranch. The Enclave was to set the stage for all other communities to follow. The purpose of these design guidelines is to allow the individual homeowner the ability to maintain their residence to the standards put forth by the original charter - the standard of being the best.

Over time homes must be maintained and elements replaced or reconstructed due to the severity of our desert climate and the lifespan of building materials and systems. Aside from the physical demands, styles and values change; what was once viewed as tasteful may no longer carry a perceived value or aesthetic interest. Materials and methods of construction improve, and advancements in technology dictate that change and evolution are necessary components to owning a house. Each individual homeowner shall have the ability to maintain and upgrade their property in a manner appropriate to their lifestyle (and to the mantra of being the best within Gainey Ranch.) These homes represent a significant investment and need to be maintained in order to hold or have their value increase. While the ability to design a custom home was an option when The Enclave was originally conceived, the following guidelines are presented to provide the individual homeowner the freedom to enhance or build upon certain features of their home. All modifications and improvements must follow these two guidelines:

1. **All proposed changes to the exterior appearance of a residence within the Enclave must be submitted to The Enclave Architectural Review Committee (“ARC”) for review and approval.** This process shall have 2 phases. First, an informal pre-design meeting shall be scheduled in which the basic design intent is presented to the Architectural review committee. During this meeting the homeowner will be given direction as to what can be allowed and what will be required for the final presentation. The Second phase will be a formal presentation in which a complete design package is presented to the Architectural Review Board (ARC), before going on to the Master Architectural Committee for final review and approval.
2. Master Architectural Rules, section 2, Article 1; Review Procedures, Paragraph B: “The MAC has adopted guidelines upon which all requests for actions or approvals from the Master Architectural Committee must be submitted. The Review Process Submittal Checklist shall indicate the number of copies of each set of plans, specifications, site plans or other documents, which must accompany applications when submitted to the Master Architectural Committee Coordinator at the Administration Office.”

All submittals shall have the following components that shall clearly illustrate the design intent of the proposed changes and how they will affect the look and feel of the residence.

- Color photographs that clearly document the existing conditions.
- Floor and site plans which clearly show the existing and proposed changes that wish to be made and how they relate to other like areas of the project.
- Professionally drawn or illustrated building elevations or 3-dimensional renderings that clearly illustrate all changes.
- Actual material samples for approval keyed back to the floor and site plan illustrations.
- \$45.00 submittal fee should be included.

Enclave Architectural Guidelines Approved by Master Architectural Committee

It is strongly recommended that all proposed changes for a single residence be submitted as a single comprehensive package so that all components can be reviewed simultaneously.

PAINTING:

All requests for painting shall be brought to the ARC. Paint colors shall be selected from the approved paint color section of these guidelines. It is not necessary for residents to have a formal presentation for repainting their house - floor plans or other illustrations are not required.

- To maintain the high design standards within The Enclave it is strongly recommended that adjacent houses not be painted the same color. A one house buffer should be maintained between like colors.
- Antiqued or faux finishes are not permitted within the enclave.
- All houses in The Enclave shall have the main body of the house painted a single color.
- All painted trim shall be in the same color as the house or conform to the accent colors shown in the paint scheme for the primary color. Only one trim color may be used.

STONE VENEERS:

Artificial stone veneers are not permitted within The Enclave. Only natural stone and natural stone thin cut veneers shall be accepted within The Enclave. Thin cut veneers must utilize corner pieces at all outside corner conditions. Individual units of stone shall have a minimum edge exposure or return of 4" at all exposed corners. Veneer materials shall be installed in such a manner that there are no exposed unfinished edges of the veneer.

- Acceptable stone patterns for The Enclave include field stone, stacked, cobble, and ashlar patterns. Flagstone or river rock patterns are not acceptable.
- Stone shall be applied as a mass; banding and wainscoting are not allowed. Stone veneers will not be allowed to stop mid-wall; massing must return or die at an inside corner.
- Stone shall only be used as an accent material. It is not permitted for entire facades of a residence to be clad with a stone veneer.
- Field stone veneer patterns shall not be applied to pop-outs on buildings at door or window surrounds. Pop-outs shall only be clad or highlighted with a limestone or weathered cast concrete material. All headers shall have the appearance of being self-supporting.
- Eroding or eroded wall details are not allowed.
- Stone veneers shall extend below the ground line to appear as if the wall is grounded. No "floating" stone details are permitted.
- Site or landscape walls must have all sides wrapped in stone to give the appearance the wall is entirely made of stone. The application of stone to a single surface of a site wall is not allowed.
- All natural stone wall caps must have a minimum thickness of 3".
- A small three-foot sample section of the veneer shall be erected and inspected by the ARC for conformance to what was submitted. After the committee has approved this sample, permission will be granted to complete the project. The ARC may issue a stop work order and require re-submittal and review for any deviations from what was approved through the design review process. All stoppages in work due to mismatched samples shall be corrected within 1 week.

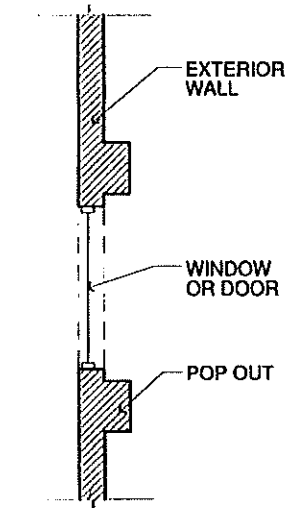

TYPICAL EXISTING POP OUT.
PLAN VIEW

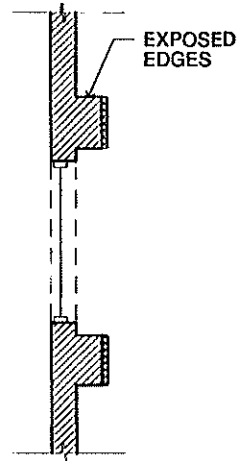

NOT ALLOWED

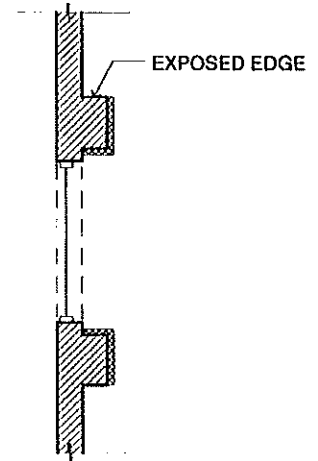

NOT ALLOWED

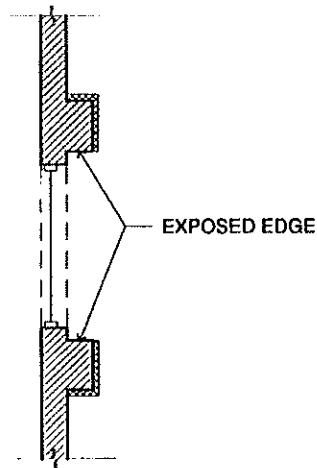

NOT ALLOWED

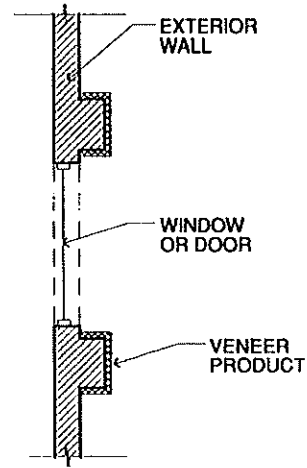

CORRECT USE OF APPROVED
VENEER MATERIAL WHERE
THE PRODUCT WRAPS ALL SIDES
OF THE POP-OUT.

STONE VENEER APPLICATION
NOT TO SCALE

1

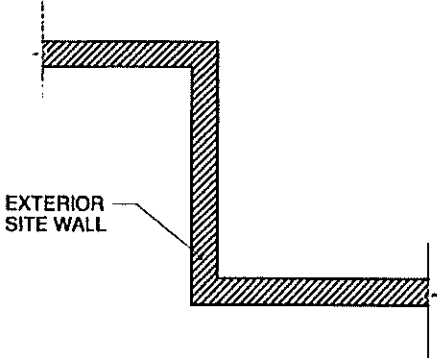

TYPICAL EXISTING CORNER CONDITION.
PLAN VIEW

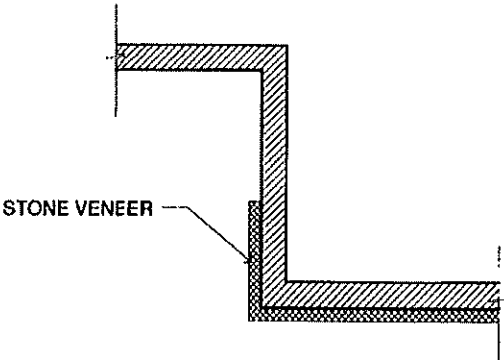

NOT ALLOWED

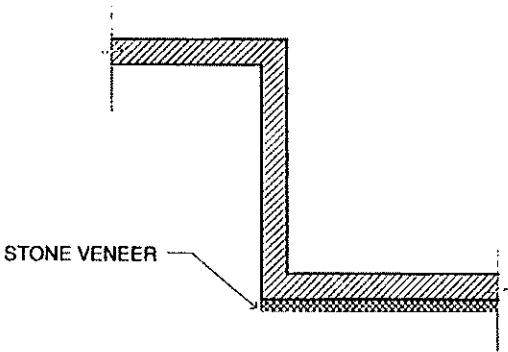

NOT ALLOWED

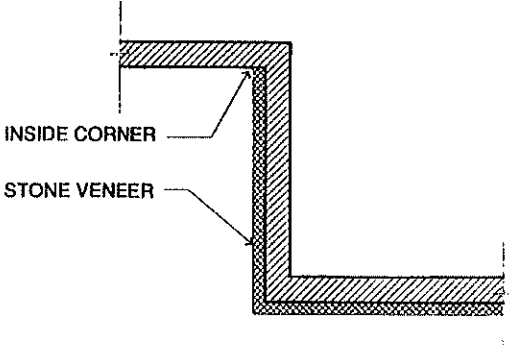

CORRECT USE OF NATURAL STONE VENEER
MATERIAL ENDS AT AN INSIDE CORNER.

STONE VENEER APPLICATION
NOT TO SCALE

2

Enclave Architectural Guidelines Approved by Master Architectural Committee

STUCCO FINISHES:

- The existing exterior stucco finish and texture on the residences at The Enclave shall be maintained as is. Any additions or repairs shall match these existing conditions.
- Integrally colored stucco finishes or antiquing shall not be allowed. All stucco finishes shall be painted an approved Enclave color.

WINDOWS AND DOOR REPLACEMENT:

- The Enclave supports the replacement of doors and windows with more energy efficient alternatives.
- All new selections shall meet minimum energy requirements as set by the current residential building codes.
- The use of colored frames shall be up to the discretion of the ARC.
- Divided lights shall be allowed as a design element within The Enclave. Any changes to the appearance of doors and windows shall carry throughout the entire residence and wrap all facades.
- Window and door openings may be made smaller or larger, change shape, and may transform from window to door and door to window. These changes shall be illustrated clearly and presented to the ARC for review and approval.
- The addition of French doors, sliding, pocketing or bi-fold systems shall also be allowed.

ROOF TILES:

The Roof tile for The Enclave shall maintain the existing flat concrete style. New colors may be brought to the ARC for consideration. Alternate materials such as Mission, S-shapes, slate, wood shake, or metal roofs shall not be allowed.

SKYLIGHTS:

- The skylights shall not be allowed to be installed on sloping roofs that are visible from the street or golf course.
- Skylights shall be allowed on flat roof systems where parapet walls totally conceal the fixture.
- All interior lighting shall be directed in a downward position so that light does not project out from the skylight.

HOUSE NUMBERS:

- The removal of the existing house numbers and replacement with the new approved style has been approved. All numbers must be placed in a clearly visible location at all times.
- Any stucco or paint damage caused as a result of the removal of the existing tiles shall be replaced and immediately painted to match the residence.

EXTERIOR LIGHTING FIXTURES:

The quantity of lighting fixtures on the market is infinite and is constantly changing. As a result, all submittals or requests to update exterior lighting fixtures shall be accompanied by a manufacturer's cut sheet and an actual sample for consideration.

- All new or replacement fixtures shall have an obscure glass to hide the bulb, or a design in which the bulb is recessed from view.
- No colored glass shall be allowed in front of the lighting source.
- If larger fixtures are selected which change the location of the electrical box, the exterior finished surfaces shall be patched and repaired to seamlessly match the exterior of the existing house. All fixtures shall be scaled properly for the location on the residence.
- All fixtures shall comply with the most current electrical and building codes.
- Energy efficient (LED or compact fluorescent) bulbs are encouraged to be used where possible. Incandescent bulbs of 60 watts or less, or the equivalent LED wattage, should be used.
- All fixtures on the exterior of a residence shall be of a consistent design style.

FRONT ENTRY GATES:

- Front entry gates shall be made of solid stock steel and finished in a color that compliments the exterior color pallet of the house. Custom colors and finishes shall be considered on a case-by-case basis.
- Designs for new gates shall be presented for review and approved on a case-by-case basis. Gates can be removed with approval.

GARAGE DOORS & DRIVEWAYS:

- Replacement garage doors with new units shall be allowed as approved.
- New garage doors may be clad with veneers such as wood or metal and may be articulated with iron detailing.
- All new garage doors or door elements shall be drawn to scale for approval.
- Driveway pavers permitted as approved by the Enclave Architectural Committee.
- Pavers to meet and be level with the existing sidewalks.

BUILDING POP-OUTS AND LET-IN DETAILING:

- Existing pop-outs on the facades of The Enclave homes can be removed, filled in or expanded in order to improve the home's overall aesthetic.
- Pop-outs may be clad with a carved stone or pre-cast concrete detailing on primary facades to accent certain primary window or door elements. These stone or concrete details must return to inside comers matching concepts put forth under the stone veneer section of these guidelines.
- Let-in details that exist on certain models shall be filled in flush if so desired.
- Glass or cable railings shall also be allowed on exterior balconies.

EXTERIOR BALCONY RAILINGS:

- The replacement of existing exterior railings with new designs shall be permitted.
- Steel railings shall be constructed from solid stock steel and powder coated or painted an approved Enclave accent color. Custom colors shall be considered on a case-by-case basis.

Enclave Architectural Guidelines Approved by Master Architectural Committee

AWNINGS:

- Ornamental awnings may be added to the exterior of the homes.
- Awnings may be constructed of steel, wood or fabric.
- Awnings made of fabric must be kept clean and free from fading. The Enclave ARC shall have the right to make homeowners remove or replace fabric awnings that are in disrepair.
- Wood and metal awnings must be maintained in original like new condition with no peeling, rust, or warping.

BALCONIES AND DECKS:

- Balconies shall be allowed to be added to the facades of homes in The Enclave and positioned such that the privacy of neighboring homes is not impeded.
- Balconies shall be sized proportionately to the opening they are being placed under and shall have detailing that makes them look supported and integrated rather than just being applied to the surface.

SHUTTERS FOR WINDOWS AND DOORS:

- Shutters may be added to both window and door elements on the exterior elevations.
- Shutters shall be proportioned to be the same width and shape as the openings they are covering.
- Shutters shall be constructed so that they appear to be operable with hinges and locking hardware.
- Shutters shall have a minimum 3/4" gap between the face of the building and the back of the shutter.
- Shutters may be stained or painted an approved Enclave accent color. Custom colors shall be considered on a case-by-case basis.

DECORATIVE CHIMNEY ELEMENTS:

- Chimney elements may be re-designed to complement and anchor the home. Features such as metal grills, stone fins or trim, and open-air designs shall be allowed.
- Minimum code clearances shall be maintained on all chimney modifications.

ARTIFICIAL PLANTS:

- Artificial plants, with the exception of artificial grass, shall not be permitted to be used as a design element facing or visible by common or rear golf course areas.
- The use of artificial plants shall be limited to the interior of individual courtyards and private backyards. Artificial plants shall be kept at a height to not be seen from neighboring houses at ground level or visible from the street.

EXTERNAL AND COMMUNAL WALLS:

- With the exception of approved pots on the two pillars on either side of the front gates, nothing shall be placed on top surfaces of exterior walls, including the common walls between the residences.

CONSTRUCTION REGULATIONS:

The failure to construct or modify any aspect of an existing residence per the approved ARC and MAC plan submittals shall result in violation of the Architectural rules and require resubmittal within two weeks of notice. Violations of the Architectural rules may result in fines and legal action to include return of the home to its original pre-construction condition.

Contractors:

All work for the sections listed above shall be performed by a licensed and bonded contractor and according to the most current building codes as adopted by the City of Scottsdale Arizona. Before any construction can commence, all contractors shall make an appointment to have a preconstruction meeting at the Gainey Ranch Administration offices. At this meeting all guidelines and rules of operation for working within Gainey Ranch will be presented to the contractor. After this meeting the Contractor shall meet with The Enclave Maintenance Department and provide current proof of licensing and bonding, as well as liability insurance as required by The Enclave. Contractors shall also provide The Enclave ARC with three professional references for review.

The quality of all work done within The Enclave shall be held to the highest quality and standards. Unsightly, sloppy, or poor workmanship may result in a stop work order and contractor removal from the jobsite.

Trash and Debris Removal:

The clean-up and removal of construction debris shall be done on a daily basis from all common areas, sidewalks, and streets. Any permanent damage or discoloring as a result of any construction project shall be corrected at the owner's expense within 2 weeks of notice. Projects shall be kept in an orderly and clean manner that is hazard-free. Littering on the job site shall be strictly enforced with potential contractor back charges and or removal from the project. Measures shall be taken to assure that debris does not blow or travel to neighboring parcels. The burning of any debris is strictly prohibited. Any damage to common area landscape or plantings shall be replaced at the owner's expense.

Project dumpsters that arrive to The Enclave shall be free from graffiti or other visually offensive graphics. Dumpsters shall be cleared immediately when full and shall not remain on any construction project longer than 60 calendar days.

Dust control shall be enforced per Maricopa County standards. Daily efforts shall be made to keep dust to a minimum and contained within the project's property boundaries.

Material storage:

The storage of building materials at a project shall be kept in an orderly manner and, where possible, out of view from the street. A daily effort shall be made to keep materials condensed and neat in appearance.

Noise control:

Music shall be kept at a volume that is not bothersome to adjacent properties.

Construction trailers:

Construction trailers shall not be allowed to be parked at a residence or on the streets of The Enclave.

Enclave Architectural Guidelines Approved by Master Architectural Committee

Parking:

Parking for a specific project within The Enclave shall be kept to the side of the street where the residence faces. If the number of vehicles for a single project becomes excessive, an offsite parking solution will be enforced.

Sanitary Facilities:

Sanitary facilities shall be provided in accordance with OSHA requirements and set back a minimum of 25' from the curb and kept on the homeowner's property. These facilities shall be screened from view.

Enforcement:

The failure to abide by any of these guidelines may result in a stop-work order. Construction shall not resume until the appropriate actions are taken.

ENCLAVE ACCESSORY GUIDELINES:

We want to keep The Enclave beautiful and improve the environment and appearance of our individual homes, but please be aware that there are certain limitations addressed below.

1. No statues, sculptures, hoses, hose containers, or other decorative items may be placed at the front of or adjacent to garage doors or in any of the front yard landscaping, unless submitted and approved by the Enclave Architectural Committee and the MAC Committee.
2. The wall outside of the courtyard of every home may have up to two (2) pots no larger than 3' in height and width. Only living plant material is allowed in the pots and is to be maintained year-round by the homeowner.
3. No accessories shall be installed or placed on top of any of the front courtyard walls or community wall that faces the Loop Road. Accessories include, but are not limited to, pots, plants, candles, statues, sculptures, or other decorative items.
4. Any homeowner who would like to put furniture on front-facing balconies must get approval from the Enclave Architectural Committee or Board. All requests will be approved on a case-by-case basis. Metal edging should be used to replace the concrete barriers around planting beds.
5. Artificial plants with the exception of artificial grass shall not be permitted as a design element facing or visible by common or golf course areas.
6. Holiday decorations cannot be set up before November 15th and must be removed no later than January 8th. Holiday lighting must be non-blinking/non-twinkling white lights only.

Barb Graham
Tim Bridges
Regina Hays

Enclave Architectural Committee

Approved: 6/2021

THE ENCLAVE ARTIFICIAL TURF GUIDELINE FOR FRONT YARDS:

The Enclave Architectural Committee has approved artificial turf for use within The Enclave Community. Homeowners are cautioned that the use of the artificial turf requires that they maintain it to the highest standards of care. Artificial turf will be considered for approval as follows:

- The only approved artificial turf for use for all front yards in The Enclave is Designer Mid. However, if a homeowner finds something comparable that is of the same or higher quality and look of the Designer Mid, The Enclave Architectural Committee will review the new turf on a case-by-case basis.
- If two homeowners living next to each other both want artificial turf, and those lawns touch, the same turf must be used for both front lawns.
- Planting beds may not have turf installed in them in order to maintain the basic layout of the front yards within The Enclave Community.
- All front yard turf submittals must identify the overall square footage of the front yard landscape space and the square footage of the artificial turf proposed for the front yard. Any rear yard turf submittal will be reviewed by The Enclave Architectural Committee on a case-by-case basis.
- The Designer Mid turf has a manufacturer life span of at least 10 years. Once the turf is at 10 years, it must be replaced with like kind turf. A regular inspection of the turf will be made and if it is deemed not in acceptable condition, at the sole discretion of The Enclave Architectural Committee, the turf will be required to be replaced, at the expense of the homeowner.
- If the artificial turf is removed, either voluntarily by lot owner or by the requirement of The Enclave Architectural Committee, and is not replaced with Designer Mid or designated alternate, the lot owner must submit a request for landscaping changes.
- When artificial turf is planned for use in heavy traffic areas, for example an area that has access to a rear yard and is used regularly, installing stepping stones, or equivalent, will likely be required to eliminate heavy traffic patterns.

Any additional landscaping or artificial turf modifications must be reviewed and approved by The Enclave Architectural Committee as well as the GRCA Master Architectural Committee. Please contact the Gainey Ranch Architectural Coordinator with any questions.

THE ENCLAVE GUTTERS & DOWNSPOUT STANDARDS:

1. Gutters and downspouts for The Enclave must be unobtrusive and individually designed for each unit using the standard approved details. The downspouts must be located on the sides or secondary elevation, not on the front elevation. They will also be located at concave comers wherever possible. The downspout must extend vertically, or in an approved manner and terminate in a manner so as not to cause erosion or cause water to become a nuisance to the existing or neighboring properties.
2. All gutters and downspouts installed are considered as an add-on installation and will be reviewed and approved on an individual basis.
3. A complete elevation plan must be submitted showing the location of the gutter and downspout on each individual residence and will be reviewed on an individual basis.
4. All installations must use the standard gutter and downspout details, colors, materials, and finishes. All support brackets must be blind mounted. Homeowners are responsible for overseeing the installation to confirm that this standard is conformed to.
5. The gutter will be the same color as the fascia and the downspout the same color as the house. These colors will be the previously approved house colors for The Enclave. Gutters and downspouts will have a primer and rust-inhibiting paint of a semi-gloss or flat finish.
6. Gutters and downspouts must be kept in a clean, neat, and painted state.

Enclave Approved Plant Vegetation

APPROVED VEGETATION:

Please refer to the Gainey Ranch Community Association website for the list of approved vegetation:

<https://gaineyranchca.com/about-grca/illustrated-plant-list/>



LARGE-CANOPY-TREES
MEDIUM-CANOPY-TREES
SMALL-CANOPY-TREES
SHRUBS-AND-GROUNDCOVER
PALMS
SUCCULENTS-AND-ACCENTS
VINES

The Enclave

Scheme 1

All Metal Work:

DE6343 Salem Black



Main House and Wall Color:

DEC726 Adobe

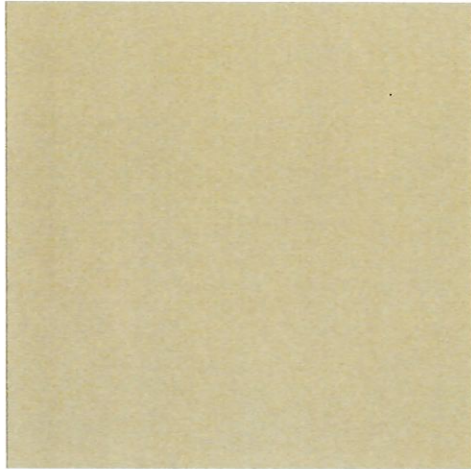

Accent Colors (may be used on wall caps, arches, columns, pop-outs, gate posts and doors):

DE6152 Maple View



DE6147 Chester Brown

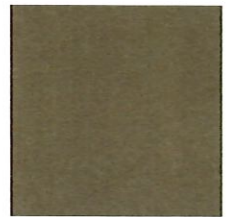

DEC764 Inside Passage



Front Door (Hi-Gloss paint suggested):

DE6152 Maple View



DE6147 Chester Brown



DEC764 Inside Passage



DEA149 Spiced Berry

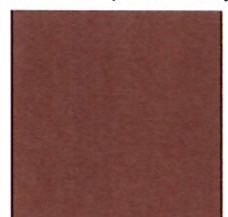

DEA184 Parisian Night



DEA180 Deep Pine



DEA176 Iron River



DEA158 Northern Territory



An additional Front Door color was approved in Jan 2011: DEA194 Mulberry



Disclaimer: Every attempt has been made to reproduce these color samples as accurately as possible. No guarantee or claim of accuracy is implied or made by this document. Please contact Dunn-Edwards for accurate color samples.

The Enclave

Scheme 2

All Metal Work:

DE6343 Salem Black



Main House and Wall Color:

DE6130 Wooded Acre

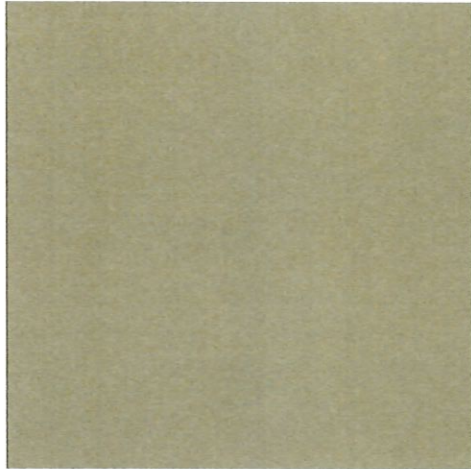

Accent Colors (may be used on wall caps, arches, columns, pop-outs, gate posts and doors):

DE6132 Big Stone Beach



DEC726 Adobe



DE6128 Sand Dune



Front Door (Hi-Gloss paint suggested):

DE6132 Big Stone Beach



DEC726 Adobe



DE6128 Sand Dune



DEA149 Spiced Berry



DEA184 Parisian Night



DEA180 Deep Pine



DEA176 Iron River



DEA158 Northern Territory



An additional Front Door color was approved in Jan 2011: DEA194 Mulberry



Disclaimer: Every attempt has been made to reproduce these color samples as accurately as possible. No guarantee or claim of accuracy is implied or made by this document. Please contact Dunn-Edwards for accurate color samples.

The Enclave

Scheme 3

All Metal Work:

DE6343 Salem Black



Main House and Wall Color:

DE6137 Tan Plan

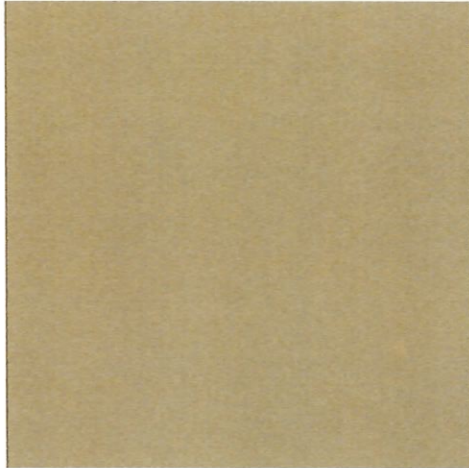

Accent Colors (may be used on wall caps, arches, columns, pop-outs, gate posts and doors):

DE6138 Dark Sepia



DE6136 Terracotta Sand



DE6134 Shortbread



Front Door (Hi-Gloss paint suggested):

DE6138 Dark Sepia



DE6136 Terracotta Sand



DE6134 Shortbread



DEA149 Spiced Berry

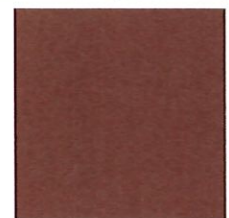

DEA184 Parisian Night



DEA180 Deep Pine



DEA176 Iron River



DEA158 Northern Territory



An additional Front Door color was approved in Jan 2011: DEA194 Mulberry



Disclaimer: Every attempt has been made to reproduce these color samples as accurately as possible. No guarantee or claim of accuracy is implied or made by this document. Please contact Dunn-Edwards for accurate color samples.

The Enclave

Scheme 4

All Metal Work:

DE6343 Salem Black



Main House and Wall Color:

DE6229 Calico Rock

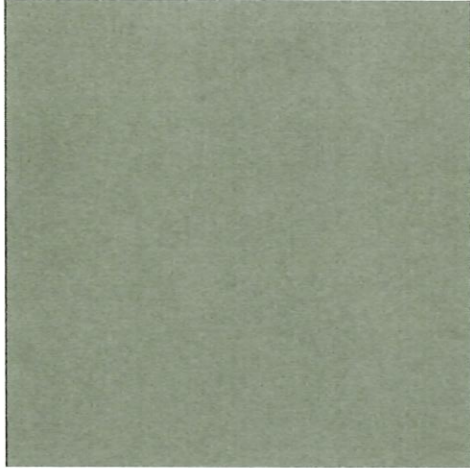

Accent Colors (may be used on wall caps, arches, columns, pop-outs, gate posts and doors):

DEC771 Shaggy Barked



DE6231 Shaker Grey



DE6220 Porous Stone



Front Door (Hi-Gloss paint suggested):

DEC771 Shaggy Barked



DE6231 Shaker Grey



DE6220 Porous Stone

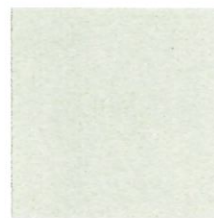

DEA149 Spiced Berry



DEA184 Parisian Night



DEA180 Deep Pine



DEA176 Iron River



DEA158 Northern Territory

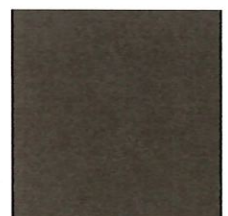

An additional Front Door color was approved in Jan 2011: DEA194 Mulberry



Disclaimer: Every attempt has been made to reproduce these color samples as accurately as possible. No guarantee or claim of accuracy is implied or made by this document. Please contact Dunn-Edwards for accurate color samples.

The Enclave

Scheme 5

All Metal Work:

DE6343 Salem Black



Main House and Wall Color:

DE6207 Egyptian Sand

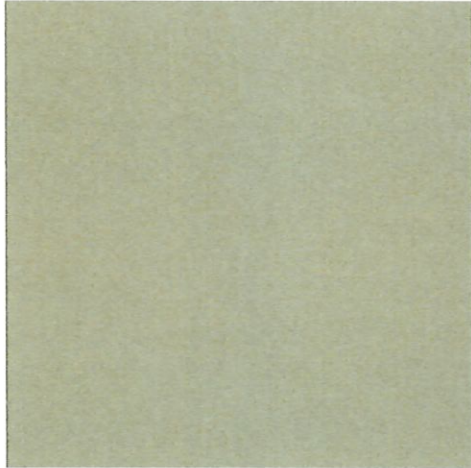

Accent Colors (may be used on wall caps, arches, columns, pop-outs, gate posts and doors):

DE6208 Tuscan Mosaic



DE6217 Ancient Earth



DEC767 Riverbed



Front Door (Hi-Gloss paint suggested):

DE6208 Tuscan Mosaic



DE6217 Ancient Earth



DEC767 Riverbed



DEA149 Spiced Berry

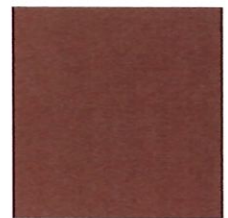

DEA184 Parisian Night



DEA180 Deep Pine



DEA176 Iron River



DEA158 Northern Territory



An additional Front Door color was approved in Jan 2011: DEA194 Mulberry



Disclaimer: Every attempt has been made to reproduce these color samples as accurately as possible. No guarantee or claim of accuracy is implied or made by this document. Please contact Dunn-Edwards for accurate color samples.

The Enclave

Scheme 6

All Metal Work:

DE6343 Salem Black



Main House and Wall Color:

DE6215 Wooden Peg

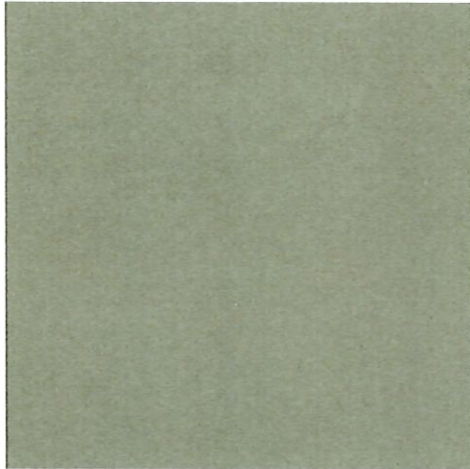

Accent Colors (may be used on wall caps, arches, columns, pop-outs, gate posts and doors):

DE6216 Barrel Stove



DE6217 Ancient Earth



DE6214 Pigeon Grey



Front Door (Hi-Gloss paint suggested):

DE6216 Barrel Stove



DE6217 Ancient Earth



DE6214 Pigeon Grey



DEA149 Spiced Berry

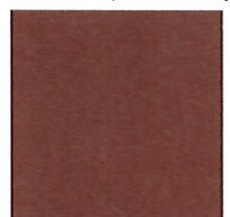

DEA184 Parisian Night



DEA180 Deep Pine



DEA176 Iron River



DEA158 Northern Territory

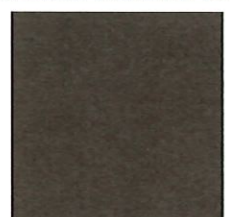

An additional Front Door color was approved in Jan 2011: DEA194 Mulberry



Disclaimer: Every attempt has been made to reproduce these color samples as accurately as possible. No guarantee or claim of accuracy is implied or made by this document. Please contact Dunn-Edwards for accurate color samples.

The Enclave

Scheme 7

All Metal Work:

DEA176 Iron River



Main House and Wall Color:

DEC750 Bison Beige

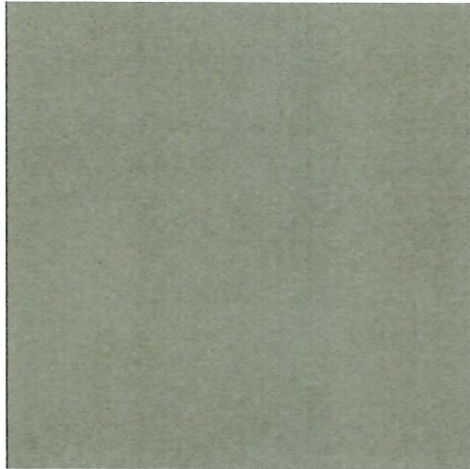

Accent Colors (may be used on wall caps, arches, columns, pop-outs, gate posts and doors):

ECC002 Enclave Graphite



ECC004 Enclave Stone



Front Door (Hi-Gloss paint suggested):

DE6152 Maple View



DE6147 Chester Brown



DEC764 Inside Passage



DEA149 Spiced Berry



DEA184 Parisian Night



DEA180 Deep Pine



DEA176 Iron River



DEA158 Northern Territory



Note: Color codes starting with ECC are custom blends



Disclaimer: Every attempt has been made to reproduce these color samples as accurately as possible. No guarantee or claim of accuracy is implied or made by this document. Please contact Dunn-Edwards for accurate color samples.

The Enclave

Scheme 8

All Metal Work:

ECC003 Enclave Slate



Main House and Wall Color:

ECC001 Enclave French Gray

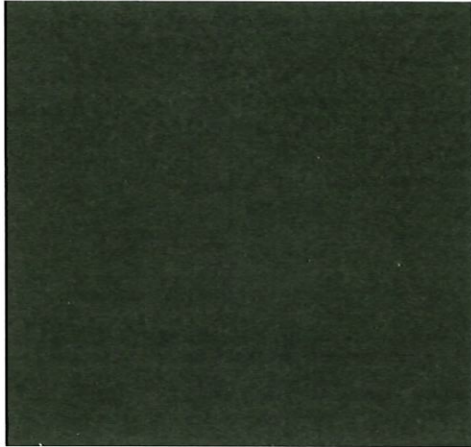

Accent Colors (may be used on wall caps, arches, columns, pop-outs, gate posts and doors):

ECC002 Enclave Graphite



ECC004 Enclave Stone



Front Door (Hi-Gloss paint suggested):

DE6152 Maple View



DE6147 Chester Brown

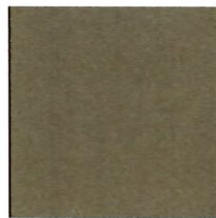

DEC764 Inside Passage



DEA149 Spiced Berry

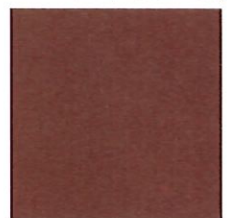

DEA184 Parisian Night



DEA180 Deep Pine



DEA176 Iron River



DEA158 Northern Territory



Note: Color codes starting with ECC are custom blends



Disclaimer: Every attempt has been made to reproduce these color samples as accurately as possible. No guarantee or claim of accuracy is implied or made by this document. Please contact Dunn-Edwards for accurate color samples.

Enclave Approved Awnings

APPROVED SUNBRELLA AWNINGS:

The following are approved awning fabric colors:

Style 4654
Linen Tweed

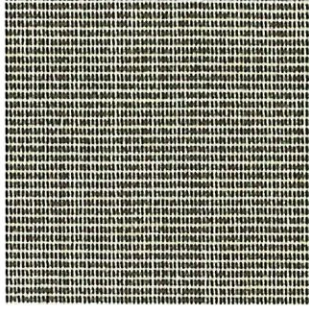

Style 4861
Silica Stone

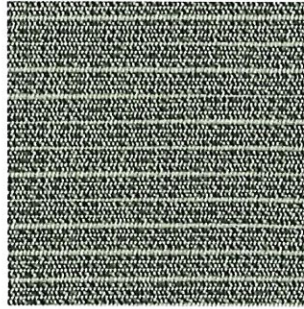

Style 4616
Mocha Tweed

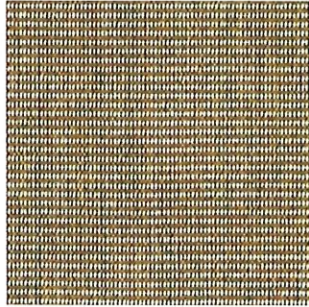

Style 4696
Tresco Birch

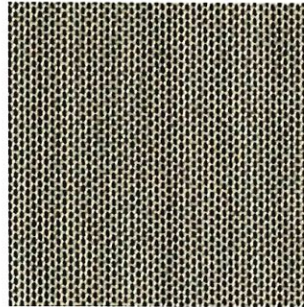

Style 4607
Charcoal Tweed

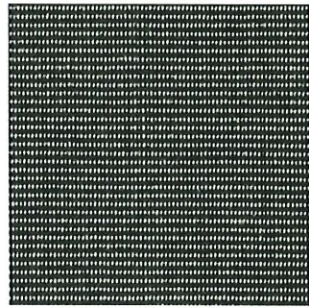

Style 4648
Taupe

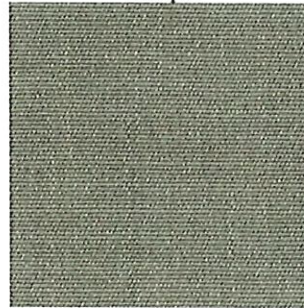

Please refer to the Sunbrella website for details:

<https://www.sunbrella.com/>

